

Elegant



This small enclosure series with its many different variations provides optimal protection for your electronic products. With or without ventilation, design covers, front panels made of aluminium or plastic and the optional design with a recessed lid for the flush fitting of membrane keypads make this enclosure ideal for many different uses.

These range from desktop, hand-held or wall enclosures to console-type models. The enclosure half shells are screwed together from the base, which ensures that the lid retains its attractive design look.

In addition, the elegant visual aspects and the appealing colour combinations highlight the value of the electronic components inside the enclosure.

In particular when used as a wall enclosure, screw fitting from the lid can be achieved by means of special processing and a set of screws available as an accessory. Wall mounting can be carried out using an integrated break-out keyhole suspension, or alternatively with mounted wall brackets.

Enclosure material: Impact-resistant polystyrene;

Colour: Lid light grey, similar to RAL 7035, base, covers and front panels agate grey, similar to RAL 7038; special colours on request.

Ingress protection: IP 40/DIN EN 60529, higher protection on request.

Scope of delivery: Lid, base, screws and cover or front panel depending on model.

Accessories (additional charge):

- EG-WL: Wall brackets (1 set = 4 pieces)
- EG-SA: Screw cover (1 set = 4 pieces)
- EG-AK: Cover for keyhole suspension (1 set = 4 pieces)
- EG-SV: Snap lock (1 set = 4 pieces)
- EG-WZ: Press-in tool for EG-SV
- EG-M...: Mounting plate
- EG-F...: Front/rear panel (aluminium anodised 1 mm)
- EG-DO...: Lid fixing set at top (4 screws incl. inserts for base)
- EG-DOB: Boring of lid for DO
- EG-GF: Rubber feet (1 set = 4 pieces)

Note:

The types available ex-works are shown on the following pages. Tooling exists for other combinations to be supplied on request for quantities of 500+.

Tip:

On EG.. B or BL, the cover panel can be removed from the outside, so coding switches etc. can be made accessible.

Also available in Elegant design:
 - console versions with or without display opening
 - plug enclosures

Enclosures Model	Dimensions		
	L	W	H
EG 1030	100	54	30
EG 1040	100	54	40
EG 1230	125	67	30
EG 1240	125	67	40
EG 1250	125	67	50
EG 1530	150	82	30
EG 1545	150	82	45
EG 1560	150	82	60
EG 2030	200	112	30
EG 2050	200	112	50
EG 2070	200	112	70

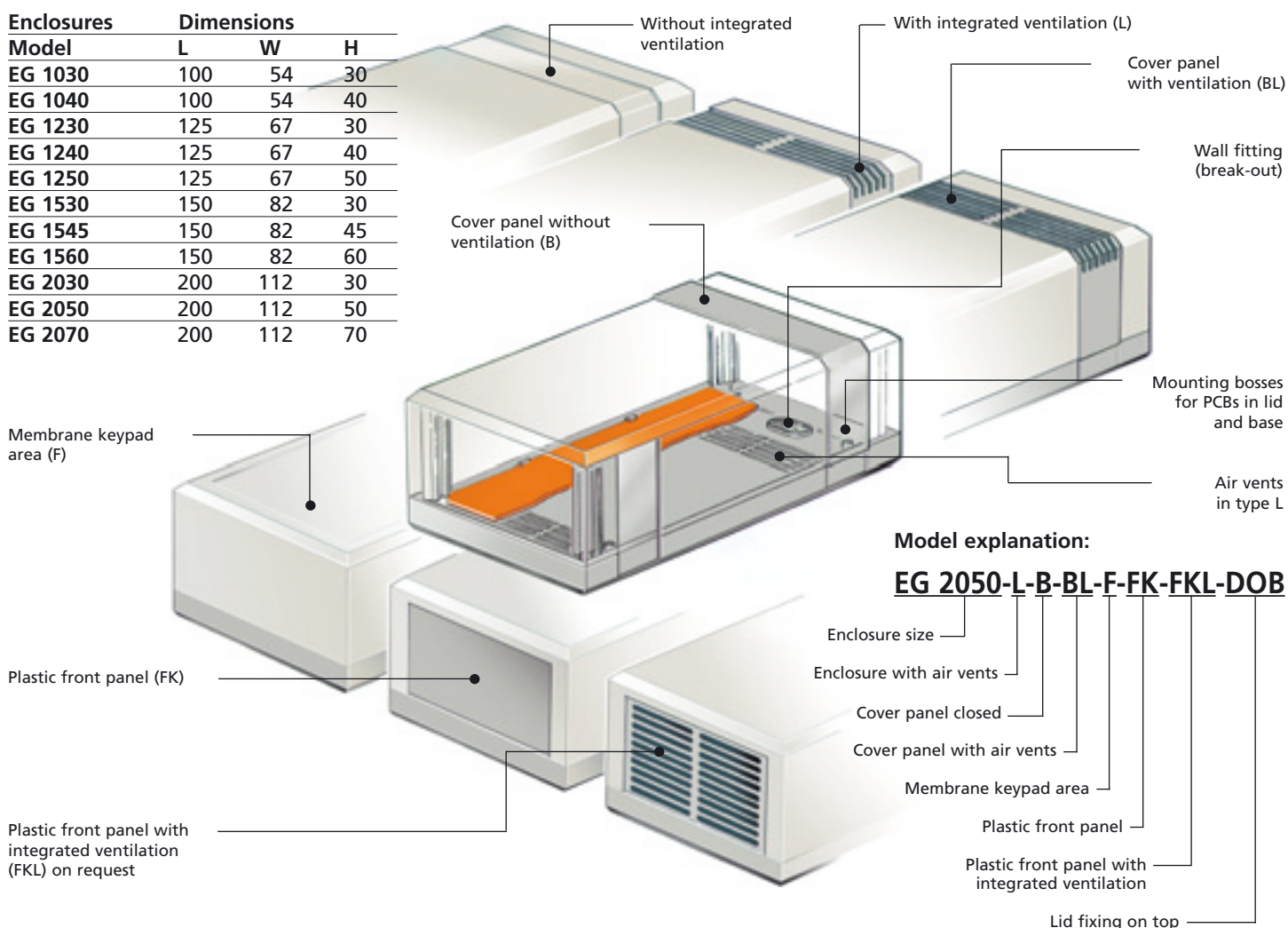

Elegant



EG 1030 L

EG 1040

Model series EG 10...



EG 1230 F

EG 1240 L-BL-FK



EG 1250

Model series EG 12...



EG-AL 1240

Models EG 10...

Order designation		External dimensions		
Model	Order no.	L	W	H
EG 1030	32103000	100	54	30
EG 1030 L	32103010	100	54	30
EG 1040	32104000	100	54	40
EG 1040 L	32104010	100	54	40

Note:

These models are without keyhole suspension.

Models EG 12...

Order designation		External dimensions		
Model	Order no.	L	W	H
EG 1230	32123002	125	67	30
EG 1230 L	32123012	125	67	30
EG 1230 B*	32123032	125	67	30
EG 1230 L-BL*	32123022	125	67	30
EG 1230 F	32123062	125	67	31
EG 1230 FL*	32123067	125	67	31
EG 1240	32124002	125	67	40
EG 1240 L	32124012	125	67	40
EG 1240 B*	32124032	125	67	40
EG 1240 L-BL*	32124022	125	67	40
EG 1240 FK	32124042	125	67	40
EG 1240 L-BL-FK*	32124057	125	67	40
EG 1240 B-FK*	32124052	125	67	40
EG 1240 F	32124062	125	67	41
EG 1240 FL*	32124067	125	67	41
EG 1250	32125002	125	67	50
EG 1250 L	32125012	125	67	50
EG 1250 B*	32125032	125	67	50
EG 1250 L-BL*	32125022	125	67	50
EG 1250 FK	32125042	125	67	50
EG 1250 L-BL-FK*	32125057	125	67	50
EG 1250 B-FK*	32125052	125	67	50
EG 1250 F	32125062	125	67	51
EG 1250 FL*	32125067	125	67	51

* available on request



Order designation		External dimensions		
Model	Order no.	L	W	H
EG-AL 1230	32123090	128,8	70,8	30
EG-AL 1240	32124090	128,8	70,8	40
EG-AL 1250	32125090	128,8	70,8	50

EG 10..
EG 12..

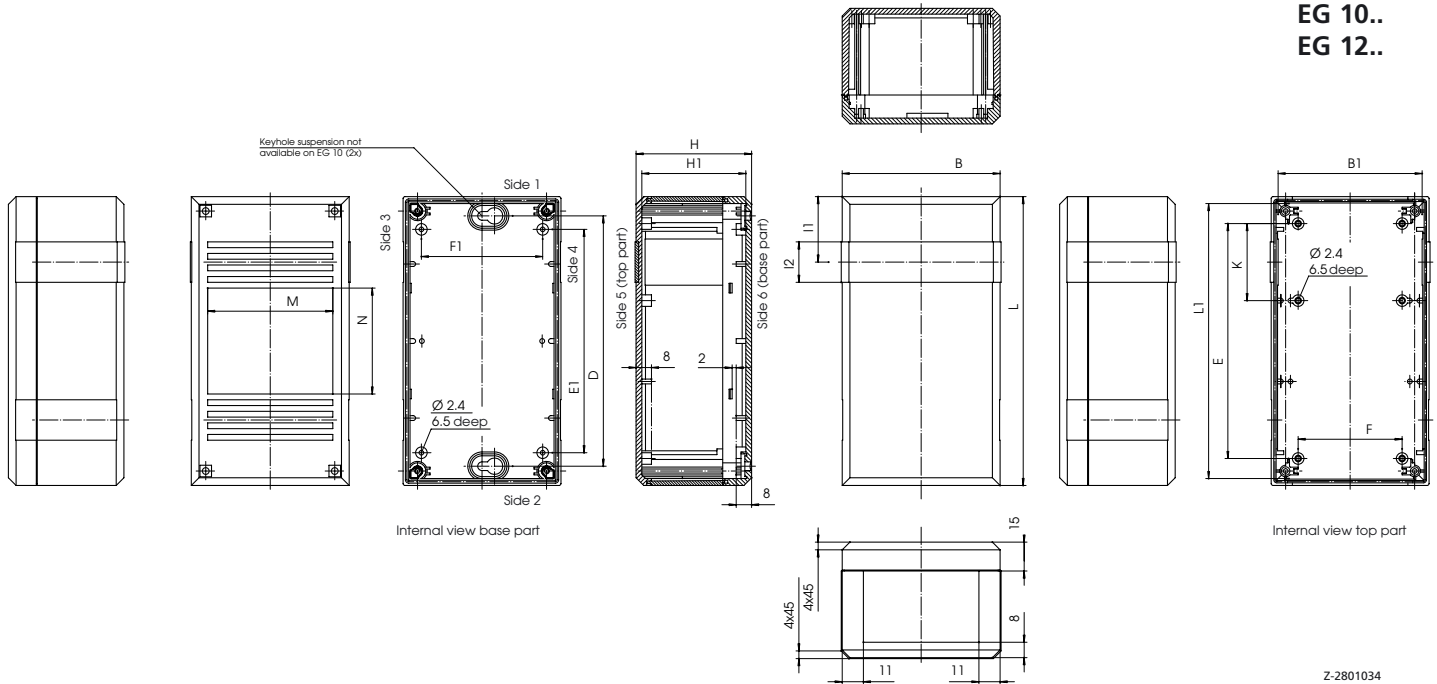

Z-2801034

Table of dimensions

Model	L	L1	B	B1	H	H1	E	E1	F	F1	D	K	I1	I2	M	N
EG 1030	100	95	54	49	30	25	66	66	39	39	-	-	27	17	37 ^{+0.2} _{-0.1}	24 ^{+0.2} _{-0.1}
EG 1040	100	95	54	49	40	35	66	66	39	39	-	-	27	17	37 ^{+0.2} _{-0.1}	24 ^{+0.2} _{-0.1}
EG 1230	125	117.8	67	59.8	30	24	97	86	39	48	105	30	29	21	50 ^{+0.2} _{-0.1}	40 ^{+0.2} _{-0.1}
EG 1240	125	117.8	67	59.8	40	34	97	86	39	48	105	30	29	21	50 ^{+0.2} _{-0.1}	40 ^{+0.2} _{-0.1}
EG 1250	125	117.8	67	59.8	50	44	97	86	39	48	105	30	29	21	50 ^{+0.2} _{-0.1}	40 ^{+0.2} _{-0.1}

EG ...F (L)

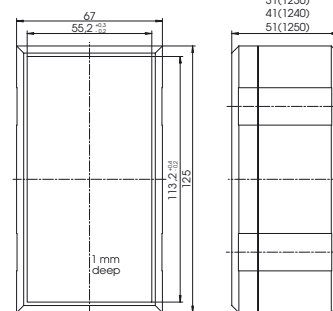

Z-2801147

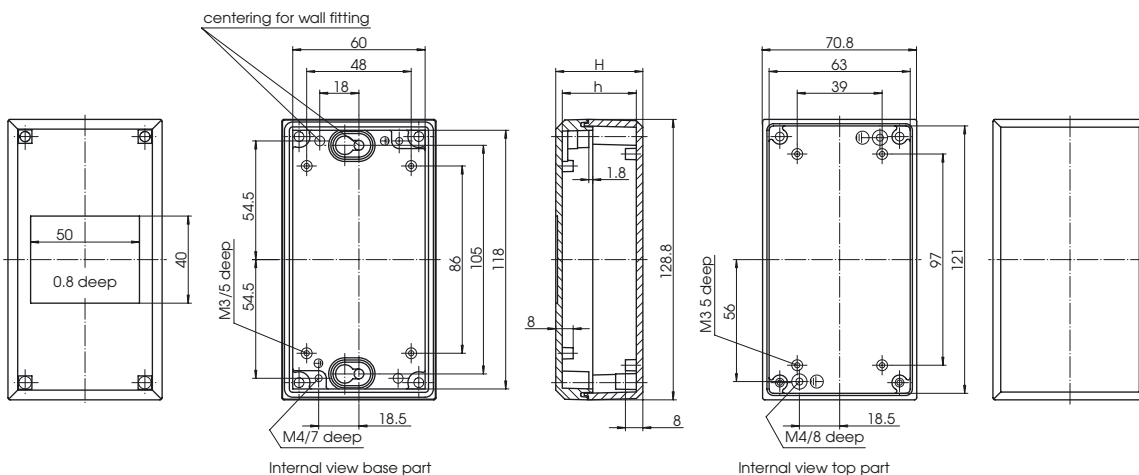

EG-AL 12..

Table of dimensions

Model	H	h
AL 1230	30	24
AL 1240	40	34
AL 1250	50	44

Z-2801625

Elegant

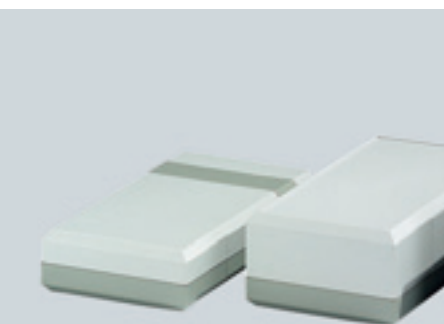

EG 1530 B

EG 1545 F



EG 1560 L-BL

Model series EG 15...

Models EG 15...

Order designation		External dimensions		
Model	Order no.	L	W	H
EG 1530	32153002	150	82	30
EG 1530 L	32153012	150	82	30
EG 1530 B*	32153032	150	82	30
EG 1530 L-BL*	32153022	150	82	30
EG 1530 F	32153062	150	82	31
EG 1530 FL*	32153067	150	82	31
EG 1545	32154502	150	82	45
EG 1545 L	32154512	150	82	45
EG 1545 B*	32154532	150	82	45
EG 1545 L-BL*	32154522	150	82	45
EG 1545 FK	32154542	150	82	45
EG 1545 L-BL-FK*	32154557	150	82	45
EG 1545 B-FK*	32154552	150	82	45
EG 1545 F	32154563	150	82	46
EG 1545 FL*	32154567	150	82	46
EG 1560	32156002	150	82	60
EG 1560 L	32156012	150	82	60
EG 1560 B*	32156032	150	82	60
EG 1560 L-BL*	32156022	150	82	60
EG 1560 FK	32156042	150	82	60
EG 1560 L-BL-FK*	32156057	150	82	60
EG 1560 B-FK*	32156052	150	82	60
EG 1560 F	32156062	150	82	61
EG 1560 FL*	32156067	150	82	61

* available on request

Models EG 20...

Order designation		External dimensions		
Model	Order no.	L	W	H
EG 2030	32203002	200	112	30
EG 2030 L	32203012	200	112	30
EG 2030 B*	32203032	200	112	30
EG 2030 L-BL*	32203022	200	112	30
EG 2030 F	32203062	200	112	31
EG 2030 FL*	32203067	200	112	31
EG 2050	32205002	200	112	50
EG 2050 L	32205012	200	112	50
EG 2050 B*	32205032	200	112	50
EG 2050 L-BL*	32205022	200	112	50
EG 2050 FK	32205042	200	112	50
EG 2050 L-BL-FK*	32205055	200	112	50
EG 2050 B-FK*	32205052	200	112	50
EG 2050 F	32205062	200	112	51
EG 2050 FL*	32205067	200	112	51
EG 2070	32207002	200	112	70
EG 2070 L	32207012	200	112	70
EG 2070 B*	32207032	200	112	70
EG 2070 L-BL*	32207022	200	112	70
EG 2070 FK	32207042	200	112	70
EG 2070 L-BL-FK*	32207057	200	112	70
EG 2070 B-FK*	32207052	200	112	70
EG 2070 F	32207062	200	112	71
EG 2070 FL*	32207067	200	112	71

* available on request

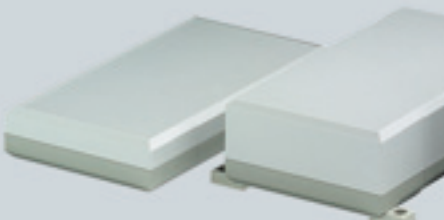

EG 2030 F

EG 2050 with WL

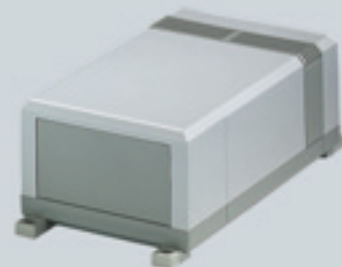

EG 2070 L-BL-FK with WL

Model series EG 20...

EG 15..
EG 20..

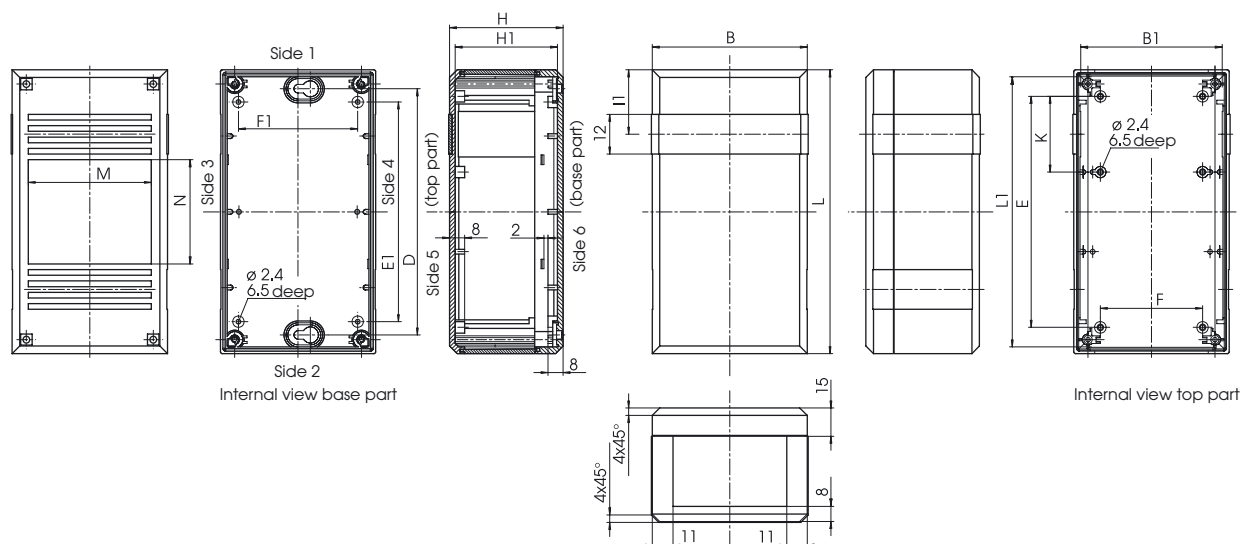

Z-2801034

Table of dimensions

Model	L	L1	B	B1	H	H1	E	E1	F	F1	D	K	I1	I2	M	N
EG 1530	150	142.8	82	74.8	30	24	122	116	54	63	130	40	34	21	65 ^{+0.3} _{-0.2}	55 ^{+0.3} _{-0.2}
EG 1545	150	142.8	82	74.8	45	39	122	116	54	63	130	40	34	21	65 ^{+0.3} _{-0.2}	55 ^{+0.3} _{-0.2}
EG 1560	150	142.8	82	74.8	60	54	122	116	54	63	130	40	34	21	65 ^{+0.3} _{-0.2}	55 ^{+0.3} _{-0.2}
EG 2030	200	192.8	112	104.8	30	24	172	153.7*	84	88.9	180	44	36	25	95	97.4
EG 2050	200	192.8	112	104.8	50	44	172	153.7*	84	88.9	180	44	36	25	95	97.4
EG 2070	200	192.8	112	104.8	70	64	172	153.7*	84	88.9	180	44	36	25	95	97.4

* 7 mm above centre point facing upwards for Euro card 100 x 160

Table of dimensions

Model	L	l	B	b	H
EG 1530 F(L)	150	138.2 ^{+0.5} _{-0.3}	82	70.2 ^{+0.3} _{-0.2}	31
EG 1545 F(L)	150	138.2 ^{+0.5} _{-0.3}	82	70.2 ^{+0.3} _{-0.2}	46
EG 1560 F(L)	150	138.2 ^{+0.5} _{-0.3}	82	70.2 ^{+0.3} _{-0.2}	61
EG 2030 F(L)	200	188.2 ^{+0.6} _{-0.3}	112	100.2 ^{+0.4} _{-0.2}	31
EG 2050 F(L)	200	188.2 ^{+0.6} _{-0.3}	112	100.2 ^{+0.4} _{-0.2}	51
EG 2070 F(L)	200	188.2 ^{+0.6} _{-0.3}	112	100.2 ^{+0.4} _{-0.2}	71

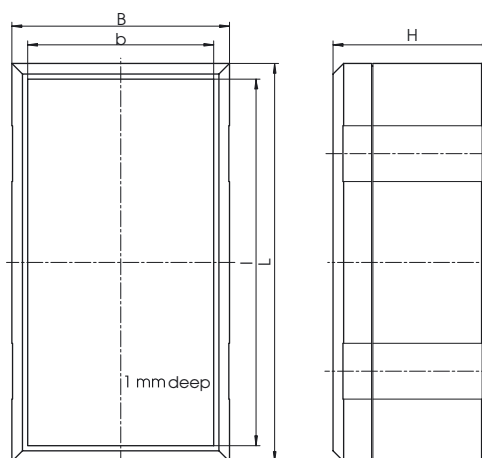

Z-2801147



Elegant accessories



Mounting plates EG-M to fit constructions in the base.

Mounting plates EG-M

Dimensions

Model	Order no.	l	b	E1	F1
EG-M 10**	33010000	77.0	45.5	66.0	39.0
EG-M 12**	33012000	101.0	59.6	86.0	48.0
EG-M 15**	33015000	126.1	74.6	116.0	63.0
EG-M 20**	33020000	176.0	104.6	153.7*	88.9

* 7 mm from centre point

** = available on request

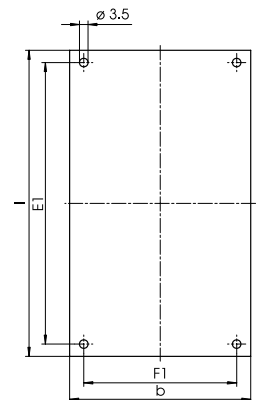

Z-2800808

Scope of delivery: 1 piece



Wall brackets EG-WL(DO) for screwing on pre-mounted complete enclosures without opening the enclosure.

Wall brackets EG-WL / EG-WL DO

Order designation

Model	Order no.
EG-WL	33000200
EG-WL DO*	33000210

* only for use with lid fixing from on top EG-DO...

Scope of delivery:

1 set = 4 wall brackets
4 screws

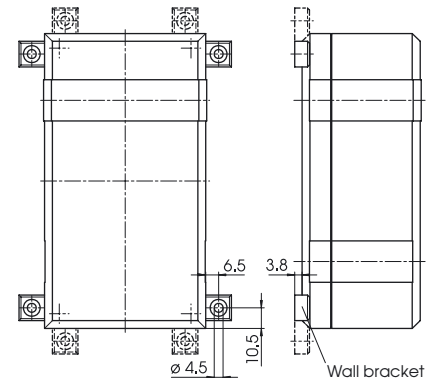

Wall bracket can be mounted, except for EG 10..
Z-2801641

Screw covers EG-SA

Order designation

Model	Order no.
EG-SA	33000300

Scope of delivery:

1 set = 4 screw covers



Screw cover EG-SA for covering enclosure screws for desktop and hand-held enclosures.

Covers EG-AK

Order designation

Model	Order no.
EG-AK	33000100

Scope of delivery:

1 set = 2 covers for keyhole suspension



Covers EG-AK for concealing key-holes (not for EG 10..).

Rear panels EG-F

Order designation

Model	Order no.	b	h
EG-F 1240*	33124000	49.6	21.9
EG-F 1250*	33125000	49.4	31.9
EG-F 1545*	33154500	64.6	26.9
EG-F 1560*	33156000	64.3	41.9
EG-F 2050*	33205000	94.7	32.2
EG-F 2070*	33207000	94.3	52.9

* = available on request

Material: Alum. anodised, 1 mm thick

Scope of delivery: 1 piece

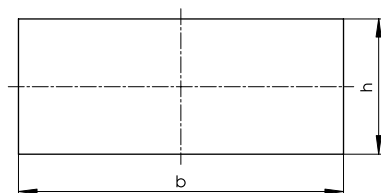

Z-2800808b

Lid fixing sets EG-DO

Order designation

Model	Order no.
EG-DO 30	33100000
EG-DO 40	33100010
EG-DO 45	33100020
EG-DO 50	33100030
EG-DO 60	33100040
EG-DO 70	33100050

Scope of delivery:

1 set = 4 screws, 4 inserts

Snap lock EG-SV

(not for EG 10...)

Order designation

Model	Order no.
EG-SV	33000400

Scope of delivery:

1 set = 4 pieces

Plastic quick-release fastening pins for pressing into the lid.

Rubber feet EG-GF

Order designation

Model	Order no.
EG-GF	25002100

Material:

Foam, grey

Scope of delivery:

1 set = 4 pieces

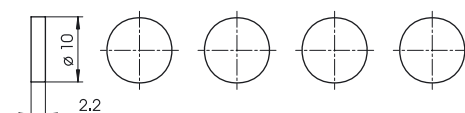

Z-2801642

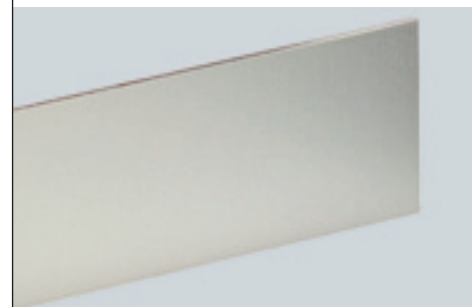

Front and rear wall panel EG-F, plug-in aluminium front panel instead of plastic front panel for type EG...FK.



Lid fixing EG-DO for fixing from on top to ensure fast access to the electronics in wall-mounted enclosures (enclosure lid needs to be processed).



Quick-release fastening EG-SV for fast, simple assembly of the two enclosure halves.



Rubber feet EG-GF guarantee non-slip safety